

# HP ProLiant ML350 G5

## Internal Options:

- CPU** 458259-B21  
2nd Quad-Core E5430  
2660MHz 2x6MB
- 397409-B21
- 397411-B21
- 397413-B21
- 397415-B21
- DDR2-SDRAM  
2x DIMMs each
- 399771-B21  
G5 2nd power
- 409579-B21  
Blower kit
- 431933-B21  
36GB 15k SAS
- 431935-B21  
72GB 15k SAS
- 431958-B21  
146GB 10k SAS
- 367047-B21  
NC320T 1000T  
PCI-E Gigabit
- 414126-B21  
NC510F One Port  
PCI-E 10-Gigabit
- A8003A  
FibChan PCI-E HBA  
2ch 4Gb FC2242SR
- 273915-B21  
Smart Array PCI-X  
6402/128 2-ch
- 435670-B21  
To convert one  
x4 to two PCI-X
- 403724-B21  
To convert two x4  
to one x8 Express
- 401222-B21  
Second serial and  
one parallel port
- 412640-B21 ML350-G5 Rack kit

## Example Configuration

Intel Xeon E5430 EM64T

2660MHz 1P-Q 458237-421 EU

Cache ECC Memory  
1 EM64T 2 2GB 2GB  
2 EM64T 2 2GB 2GB

Intel 5000Z 1333MHz FSB

iLO2 PWR 399771-B21 2+2+2  
USB 2.0

ATI ES1000 Serial  
E2001/128

ProLiant ML350 G5

8-port SAS DVD R/W

414126-B21 x4 8-port SAS SATA

374654-B21 100 U320 DAT72 36GB Q1522B

273915-B21 133MHz 3xPCI-X

431935 15k SAS72G 4 3 2 1

431935 15k SAS72G 4 3 2 1

431958 10k SAS146G 4 3 2 1

347708 15k SAS146G 4 3 2 1

347708 15k SAS146G 4 3 2 1

347708 15k SAS146G 4 3 2 1

347708 15k SAS146G 4 3 2 1

347708 15k SAS146G 4 3 2 1

347708 15k SAS146G 4 3 2 1

347708 15k SAS146G 4 3 2 1

347708 15k SAS146G 4 3 2 1

347708 15k SAS146G 4 3 2 1

347708 15k SAS146G 4 3 2 1

347708 15k SAS146G 4 3 2 1

347708 15k SAS146G 4 3 2 1

347708 15k SAS146G 4 3 2 1

347708 15k SAS146G 4 3 2 1

347708 15k SAS146G 4 3 2 1

347708 15k SAS146G 4 3 2 1

This is a Rack system

External Two Channel SCSI

302970-B21 MSA30 DB

347708 15k SAS146G 4 3 2 1

347708 15k SAS146G 4 3 2 1

347708 15k SAS146G 4 3 2 1

347708 15k SAS146G 4 3 2 1

347708 15k SAS146G 4 3 2 1

347708 15k SAS146G 4 3 2 1

347708 15k SAS146G 4 3 2 1

347708 15k SAS146G 4 3 2 1

347708 15k SAS146G 4 3 2 1

347708 15k SAS146G 4 3 2 1

347708 15k SAS146G 4 3 2 1

347708 15k SAS146G 4 3 2 1

347708 15k SAS146G 4 3 2 1

347708 15k SAS146G 4 3 2 1

347708 15k SAS146G 4 3 2 1

347708 15k SAS146G 4 3 2 1

347708 15k SAS146G 4 3 2 1

347708 15k SAS146G 4 3 2 1

Link to this document:

<http://goldeneggs.spyderbyte.com/geggs/GEIML350G5x.pdf>

## 2660MHz Dual- or Quad-Core

Intel Xeon E5430 EM64T

2660MHz 1P-Q 458238-421 EU

Cache ECC Memory  
1 EM64T 2 2GB 2GB

Intel 5000Z 1333MHz FSB

iLO2 PWR 399771-B21 2+2+2  
USB 2.0

ATI ES1000 Serial  
E2001/128

ProLiant ML350 G5

8-port SAS DVD R/W

414126-B21 x4 8-port SAS SATA

374654-B21 100 U320 DAT72 36GB Q1522B

273915-B21 133MHz 3xPCI-X

431933 15k SAS72G 4 3 2 1

431935 15k SAS72G 4 3 2 1

431958 10k SAS146G 4 3 2 1

347708 15k SAS146G 4 3 2 1

347708 15k SAS146G 4 3 2 1

347708 15k SAS146G 4 3 2 1

347708 15k SAS146G 4 3 2 1

347708 15k SAS146G 4 3 2 1

347708 15k SAS146G 4 3 2 1

347708 15k SAS146G 4 3 2 1

347708 15k SAS146G 4 3 2 1

347708 15k SAS146G 4 3 2 1

347708 15k SAS146G 4 3 2 1

347708 15k SAS146G 4 3 2 1

347708 15k SAS146G 4 3 2 1

347708 15k SAS146G 4 3 2 1

347708 15k SAS146G 4 3 2 1

347708 15k SAS146G 4 3 2 1

347708 15k SAS146G 4 3 2 1

MS Windows Server 2000  
MS Windows Server 2003  
Novell NetWare  
Linux: Red Hat, SuSE  
VMware Virtualization Software

<http://www.LinuxHPC.org>  
<http://www.WinHPC.org>

Golden Eggs home:  
<http://goldeneggs.spyderbyte.com/>

© 2008 Matti Patari, All rights reserved.

GOLDEN EGGS Visuals Helsinki 13-Jan-2008 GEIML350G5a Matti.Patari@Kolumbus.Fi

HP ProLiant ML350 G5 E5430 2660MH  
GOLDEN EGGS Visuals, Helsinki

First rev 10-Jan-08

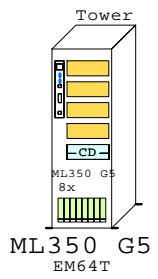
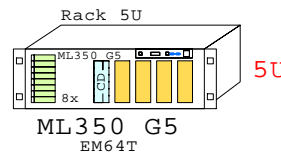
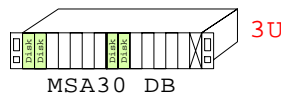
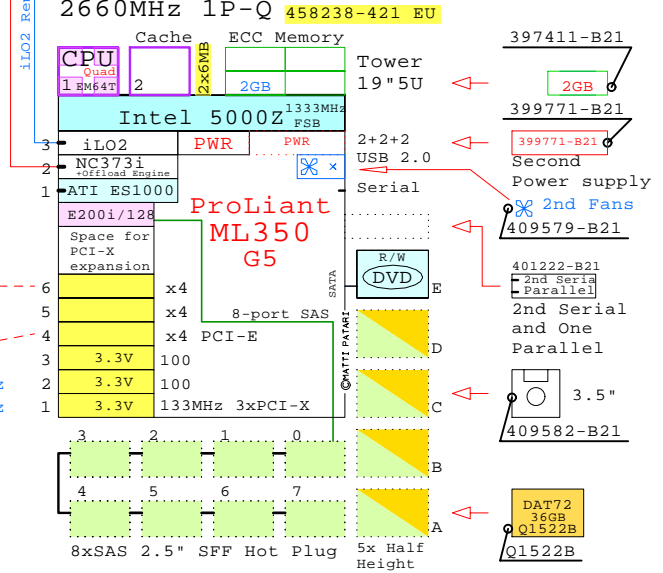
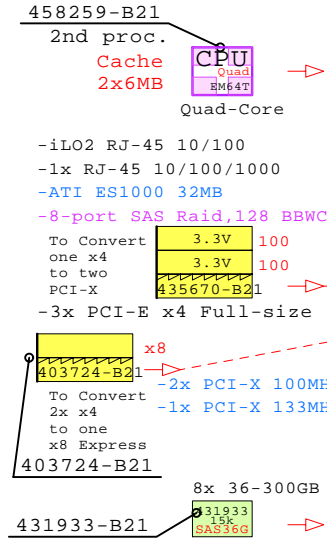

## Parts list for the Quad-Core E5430 system above

Part Number	Qty	Description
458237-421	1	ML350 G5 1P QC E5430-2x6MB 2GB SFF Rack
273915-B21	1	Smart Array 6402/128 Ultra320 2-chan
374654-B21	1	HP Single Ch U320 SCSI HBA
397411-B21	3	HP Blade BL460c Memory 2GB 2x1GB
399771-B21	1	DL380 G5 second power supply WW
409579-B21	1	Hot plug blower kit, ML350 G5
414126-B21	1	HP NC510F PCI-E 10-Gigabit Server Adapter
431935-B21	8	HP 72GB SAS 15000r hot-plug disk 2.5"
458259-B21	1	Xeon QC E5430-2x6MB 2660MHz for ML350G5
Q1522B	1	HP DAT 72 36GB internal drive
302970-B21	1	MSA30 Dual Buss Ultra320 7+7 1"
347708-B21	12	146.8GB 15000r U320 disk 1"

For more detailed configuring, please consult the latest HP QuickSpecs or VisioCafe.com. All trademarks in this document are those of their owners.

# ML350 G5 2P

# 2660MHz Dual- or Quad-Core

Intel Xeon E5430 EM64T  
 2660MHz 1P-Q **458238-421 EU**

Memory Max:  
 4x8GB=32GB

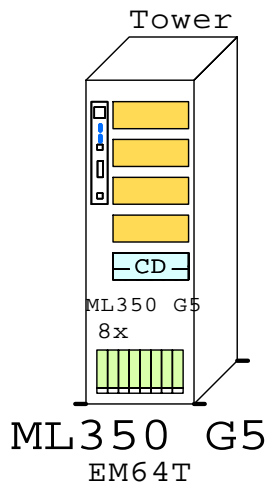

458259-B21  
 2nd proc.  
 Cache  
 2x6MB  
**CPU**  
 Quad  
 EM64T  
 Quad-Core

Gigabit E  
 iLO2 Remote Manager

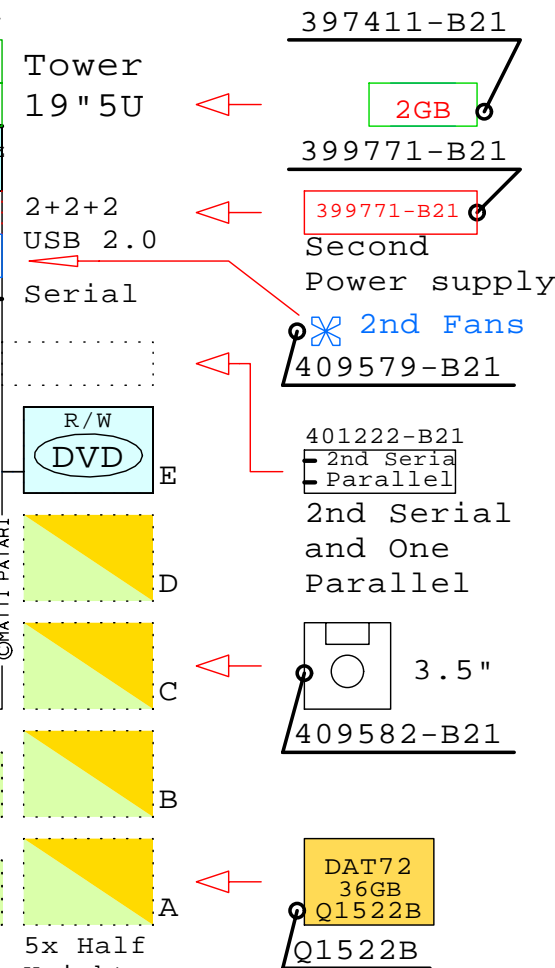
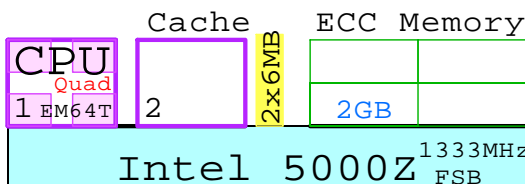

- iLO2 RJ-45 10/100
- 1x RJ-45 10/100/1000
- ATI ES1000 32MB
- 8-port SAS Raid, 128 BBWC

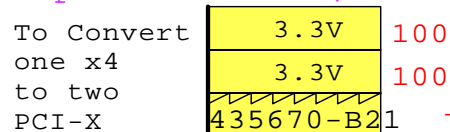

-3x PCI-E x4 Full-size

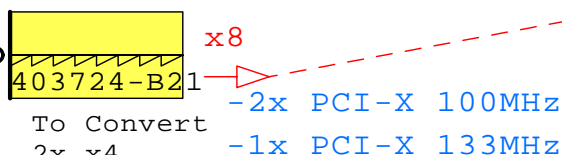

403724-B21

8x 36-300GB  
 431933-B21  
 31933 15k SAS36G

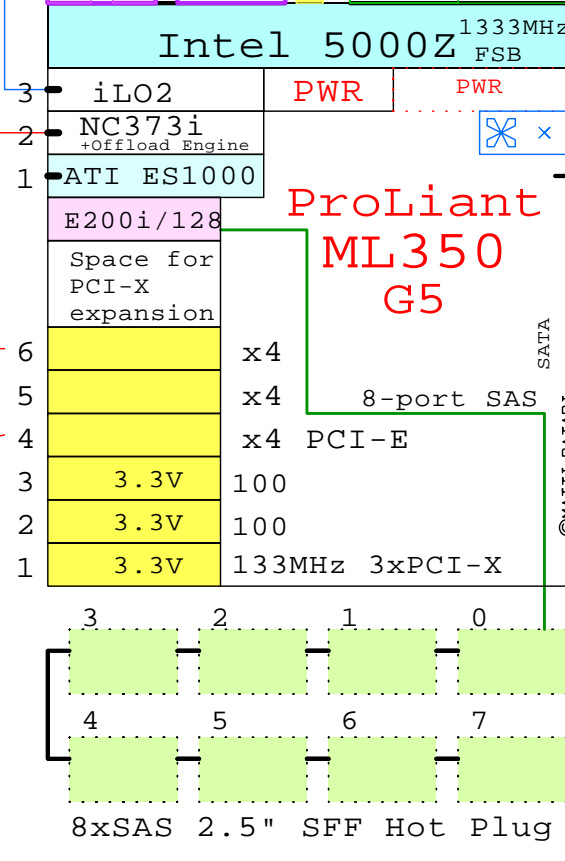

ProLiant  
**ML350  
 G5**

10-Gigabit

Gigabit E

iLO2 Remote Manager

# HP ProLiant ML350 G5 Example Configuration

Intel Xeon E5430 EM64T  
2660MHz 1P-Q 458237-421 EU

Parts list for the Quad-Core E5430 system above

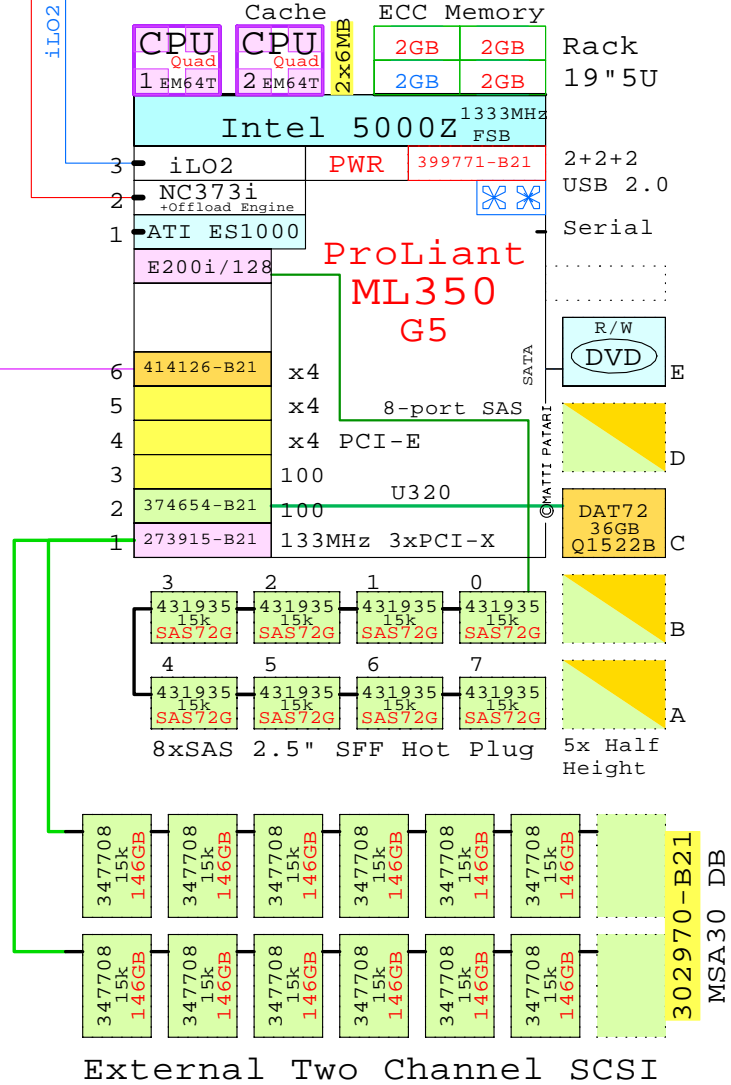

	Part Number	Qty	Description
1	458237-421	1	ML350 G5 1P QC E5430-2x6MB 2GB SFF Rack
1.1	273915-B21	1	Smart Array 6402/128 Ultra320 2-chan
1.2	374654-B21	1	HP Single Ch U320 SCSI HBA
1.3	397411-B21	3	HP Blade BL460c Memory 2GB 2x1GB
1.4	399771-B21	1	DL380 G5 second power supply WW
1.5	409579-B21	1	Hot plug blower kit, ML350 G5
1.6	414126-B21	1	HP NC510F PCI-E 10-Gigabit Server Adapte
1.7	431935-B21	8	HP 72GB SAS 15000r hot-plug disk 2.5"
1.8	458259-B21	1	Xeon QC E5430-2x6MB 2660MHz for ML350G5
1.9	Q1522B	1	HP DAT 72 36GB internal drive
2	302970-B21	1	MSA30 Dual Buss Ultra320 7+7 1"
2.1	347708-B21	12	146.8GB 15000r U320 disk 1"

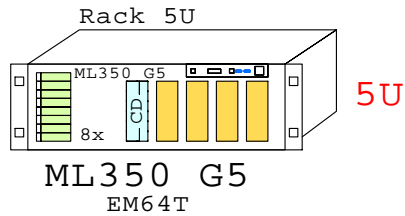

5U

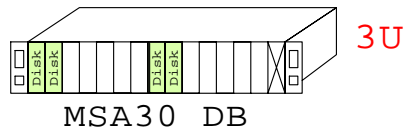

3U

Golden Eggs home:  
<http://goldeneggs.spyderbyte.com/>  
Matti.Patari@Kolumbus.Fi

Link to this document:  
<http://goldeneggs.spyderbyte.com/geggs/GEIML350G5x.pdf>