

2200MHz Quad-Core

AMD64 Opteron 8354

2200MHz 2P-Quad 448187-421

Memory Max:
16x8GB=128GB

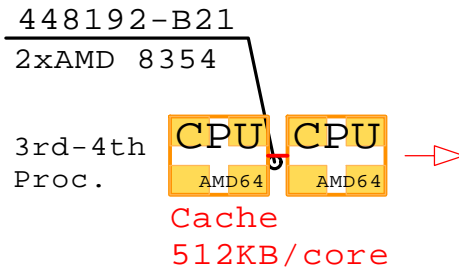

Gigabit E
Gigabit E
iLO2 Remote Manager

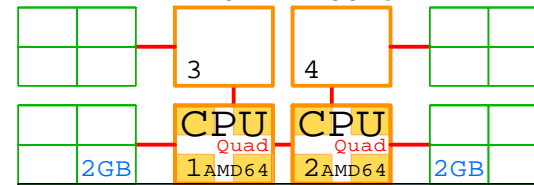

Rack
19" 4U

408851-B21

2GB

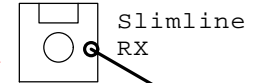

390164-B21

348114-B21

348114-B21
2nd Power Supply

- iLO2 RJ-45 10/100
- 2x RJ-45 10/100/1000
- ATI-RN50 32MB
- 8-port SAS Raid, 256MB
- 3x PCI-E x8 Full-length
- 4x PCI-E x4 Full-length
- 1x PCI-X 100MHz Full-length
- 1x PCI-X 100MHz Half-length

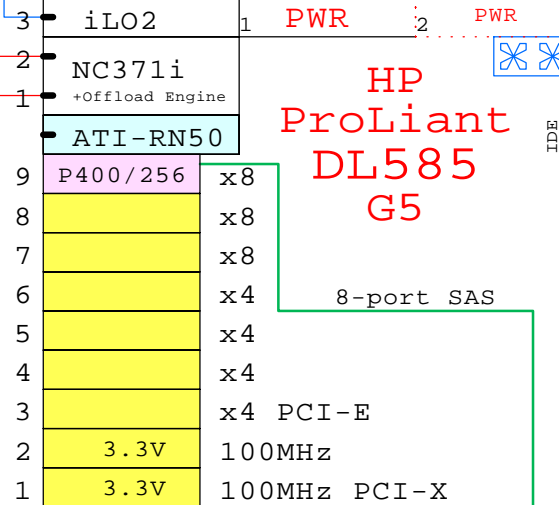

Kb, Mouse
Serial
2+2+1
USB 2.0

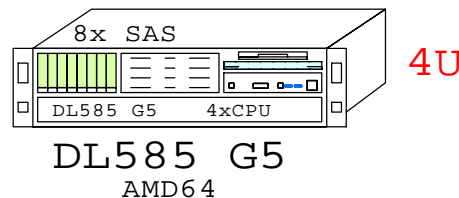
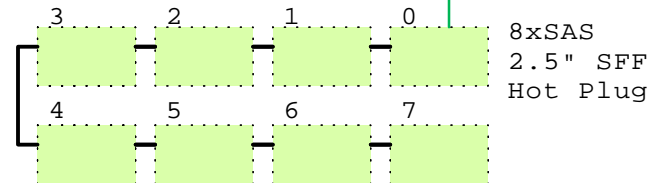
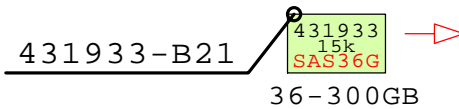

Matti.Patari@Kolumbus.Fi

Golden Eggs home:
<http://goldeneggs.spyderbyte.com/>

Link to this document:
<http://goldeneggs.spyderbyte.com/geggs/GEODL585G5x.pdf>

HP ProLiant DL585 G5 Example Configuration

AMD64 Opteron 8356

2300MHz 4P-Quad 448188-421

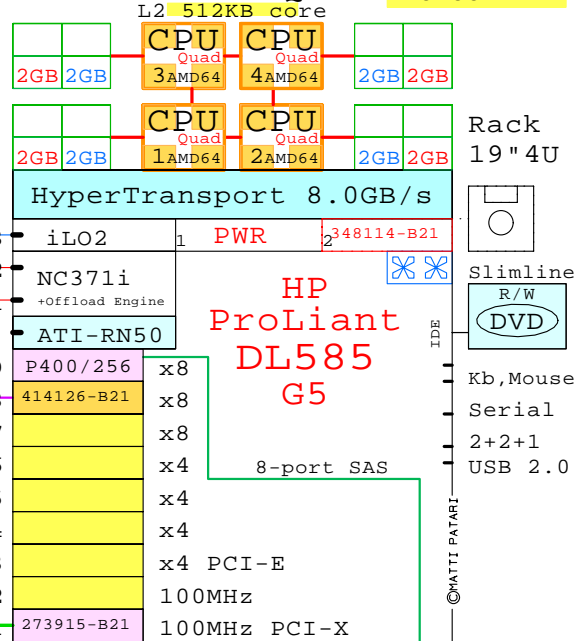

External Two Channel SCSI

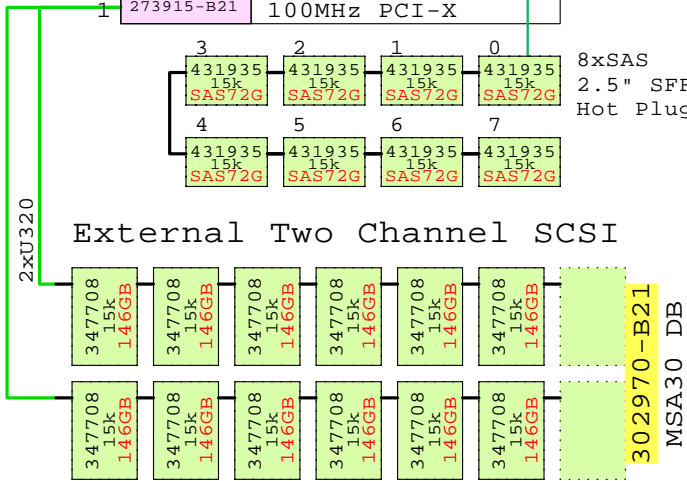

Parts list for the 4P Quad-Core Opteron 8356 2.3GHz system

	Part Number	Qty	Description
1	448188-421	1	DL585 G5 4P QC AMD8356 4x512KB 8GB 2.3GH
1.1	273915-B21	1	Smart Array 6402/128 Ultra320 2-chan
1.2	348114-B21	1	DL580 G3 second power supply
1.3	390164-B21	1	DL580 G3 Slimline Floppy Drive
1.4	408851-B21	4	2GB PC2-5300 DDR2 kit 2x1GB DL385G2
1.5	414126-B21	1	HP NC510F PCI-E 10-Gigabit Server Adapte
1.6	431935-B21	8	HP 72GB SAS 15000r hot-plug disk 2.5"
2	302970-B21	1	MSA30 Dual Buss Ultra320 7+7 1"
2.1	347708-B21	12	146.8GB 15000r U320 disk 1"

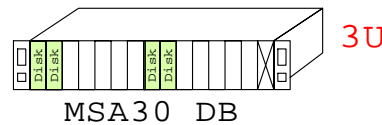
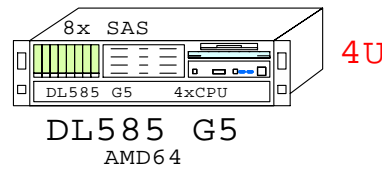

Matti.Patari@Kolumbus.Fi

Golden Eggs home:
<http://goldeneggs.spyderbyte.com/>

Link to this document:
<http://goldeneggs.spyderbyte.com/geggs/GEODL585G5x.pdf>